

X is for Xylophone

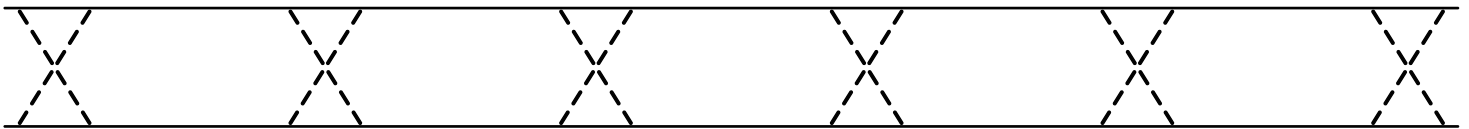

Name:

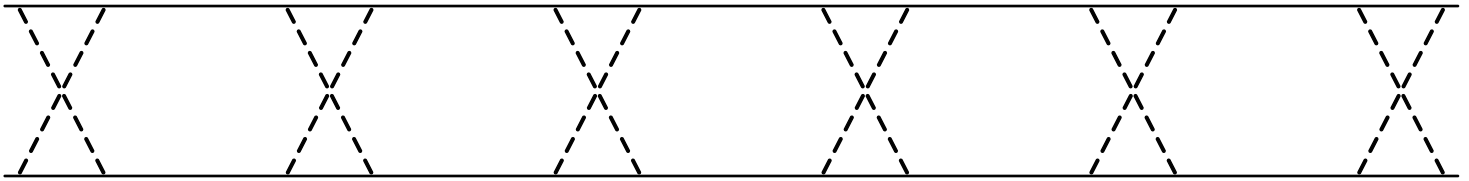
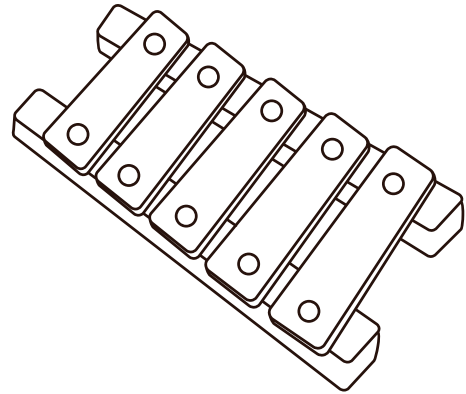
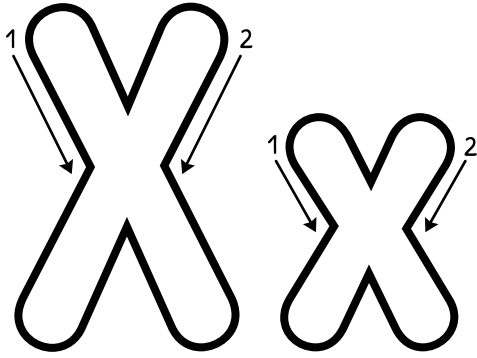

Color this letter !

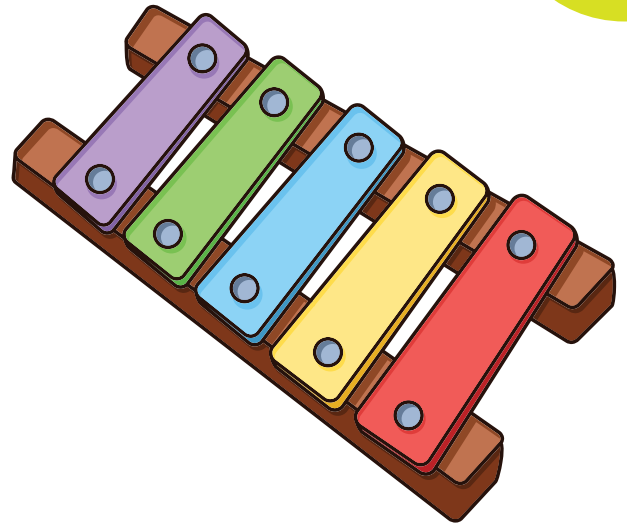

XYLOPHONE

Trace this letter !

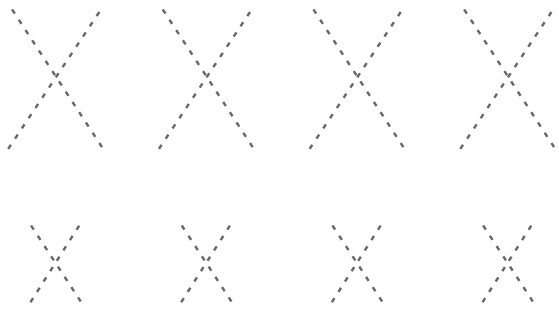

Find letter X !

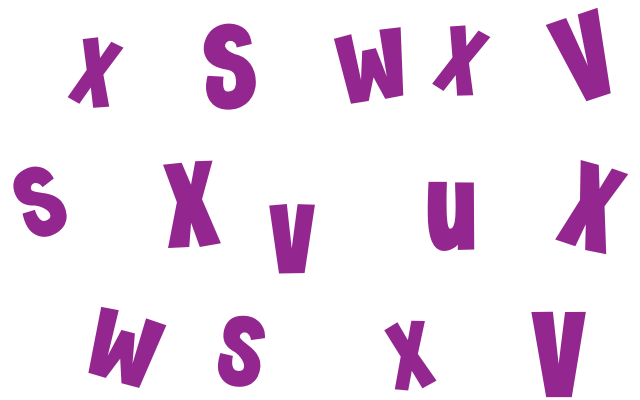

Trace the Line !

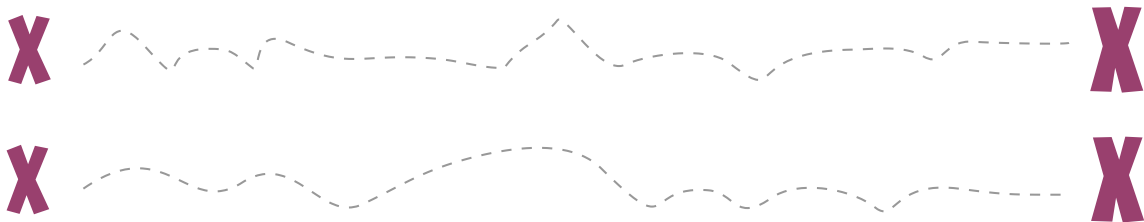



Name:



Find the missing letter

X	E	W
		
_ Ray		

c	x	u
		
Bo _		

c	x	b
		
A _ e		

Letter X worksheet cut and paste



Xenops

Xylophone

X-ray

